

# HMC391LP4

## MMIC VCO w/ BUFFER AMPLIFIER, 3.9 - 4.45 GHz

### Typical Applications

Low noise MMIC VCO w/Buffer Amplifier for:

- VSAT & Microwave Radio
- Radio Altimetry
- Test Equipment & Industrial Controls
- Military

### Functional Diagram

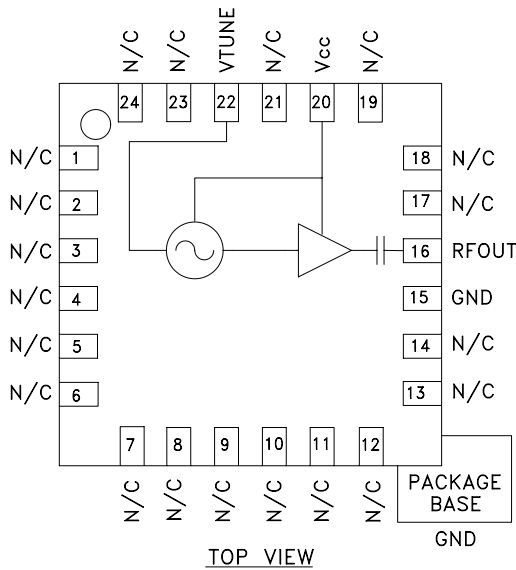

### Features

- Pout: +5.0 dBm
- Phase Noise: -106 dBc/Hz @100 KHz
- No External Resonator Needed
- Single Supply: +3V @ 30 mA
- QFN Leadless SMT Package, 16 mm<sup>2</sup>

### General Description

The HMC391LP4 is a GaAs InGaP Heterojunction Bipolar Transistor (HBT) MMIC VCO with integrated resonator, negative resistance device, varactor diode, and buffer amplifier. Covering 3.9 to 4.45 GHz, the VCO's phase noise performance is excellent over temperature, shock, vibration and process due to the oscillator's monolithic structure. Power output is 5.0 dBm typical from a single supply of +3V @ 30 mA. The voltage controlled oscillator is packaged in a low cost leadless QFN 4 x 4 mm surface mount package.

### Electrical Specifications, $T_A = +25^\circ C, V_{cc} = +3V$

Parameter	Min.	Typ.	Max.	Units
Frequency Range	3.9 - 4.45			GHz
Power Output	1.5	5.0		dBm
SSB Phase Noise @ 100 kHz Offset, Vtune= +5V @ RF Output		-106		dBc/Hz
Tune Voltage (Vtune)	0		10	V
Supply Current (Icc) (Vcc = +3.0V)		30		mA
Tune Port Leakage Current			10	µA
Output Return Loss		7		dB
Harmonics 2nd 3rd		-9 -23		dBc dBc
Pulling (into a 2.0:1 VSWR)		8.0		MHz pp
Pushing @ Vtune= +5V		16		MHz/V
Frequency Drift Rate		0.5		MHz/°C

For price, delivery, and to place orders, please contact Hittite Microwave Corporation:  
 12 Elizabeth Drive, Chelmsford, MA 01824 Phone: 978-250-3343 Fax: 978-250-3373  
 Order Online at [www.hittite.com](http://www.hittite.com)

## MMIC VCO w/ BUFFER AMPLIFIER, 3.9 - 4.45 GHz

**Frequency vs. Tuning Voltage,  $T = 25^{\circ}\text{C}$**

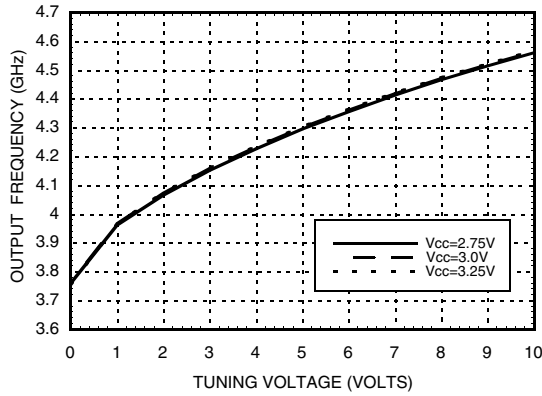

**Frequency vs. Tuning Voltage,  $V_{cc} = +3V$**

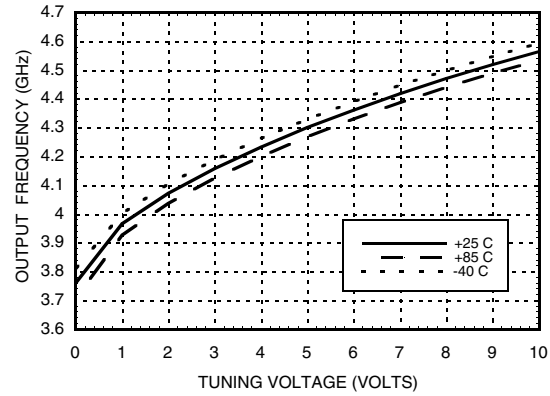

**Sensitivity vs. Tuning Voltage,  $V_{cc} = +3V$**

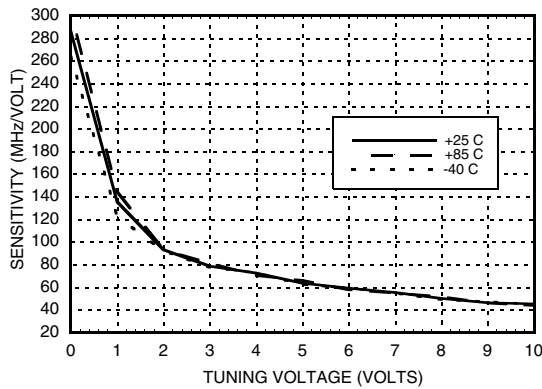

**Output Power vs. Tuning Voltage,  $V_{cc} = +3V$**

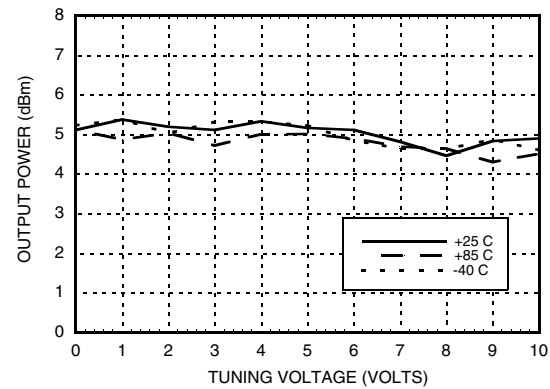

**Phase Noise vs. Tuning Voltage**

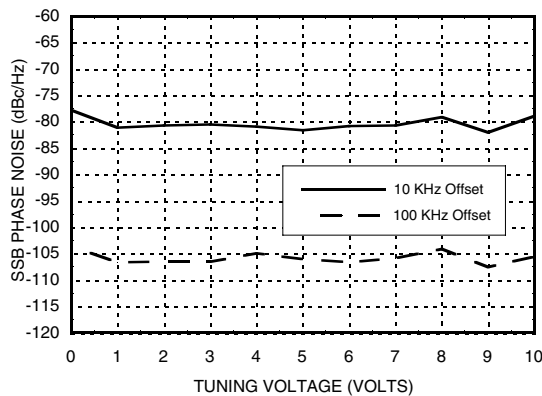

**Typical SSB Phase Noise @  $V_{tune} = +5V$**

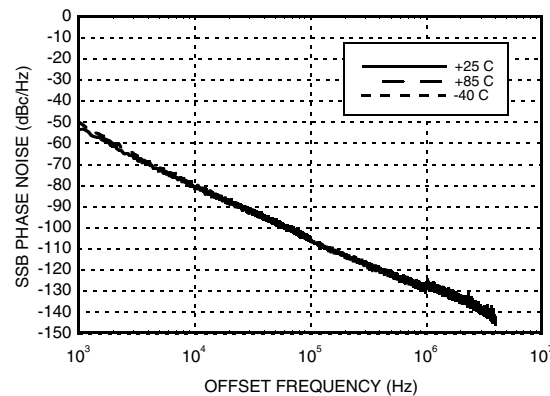

## MMIC VCO w/ BUFFER AMPLIFIER, 3.9 - 4.45 GHz

### Absolute Maximum Ratings

Vcc	+3.5 Vdc
Vtune	0 to +11V
Channel Temperature	135 °C
Continuous P <sub>diss</sub> (T = 85°C) (derate 6.28 mW/°C above 85°C)	565 W
Storage Temperature	-65 to +150 °C
Operating Temperature	-40 to +85 °C

### Typical Supply Current vs. Vcc

Vcc (V)	Icc (mA)
2.75	22
3.0	30
3.25	39

Note: VCO will operate over full voltage range shown above.

### Outline Drawing

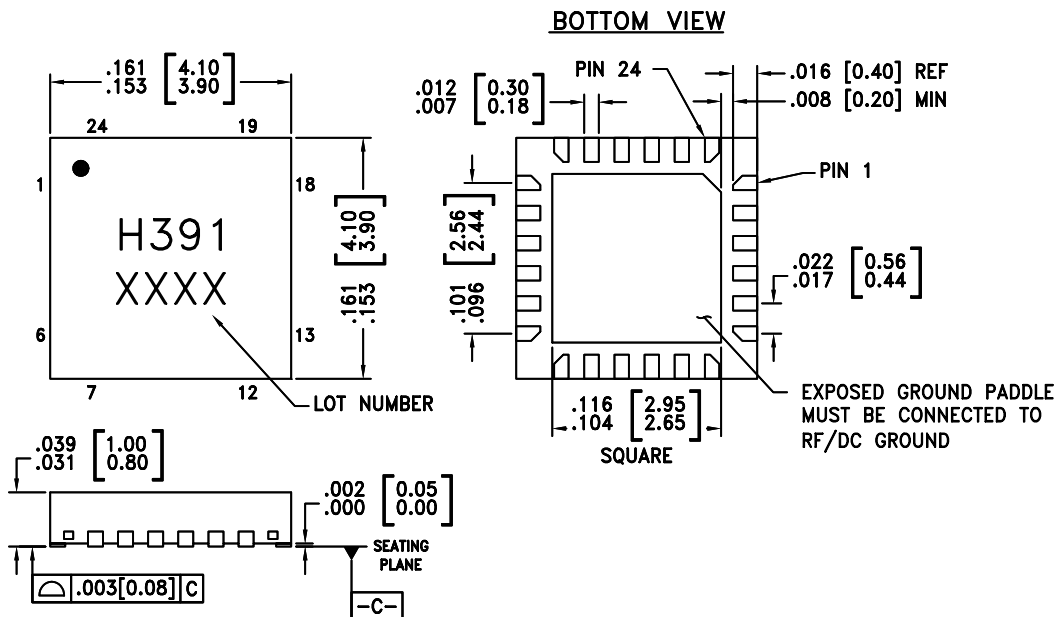



#### NOTES:

1. MATERIAL PACKAGE BODY: LOW STRESS INJECTION MOLDED PLASTIC SILICA AND SILICON IMPREGNATED.
2. LEAD AND GROUND PADDLE MATERIAL: COPPER ALLOY
3. LEAD AND GROUND PADDLE PLATING: Sn/Pb SOLDER
4. DIMENSIONS ARE IN INCHES [MILLIMETERS].
5. LEAD SPACING TOLERANCE IS NON-CUMULATIVE
6. PAD BURR LENGTH SHALL BE 0.15mm MAXIMUM.  
PAD BURR HEIGHT SHALL BE 0.05mm MAXIMUM.
7. PACKAGE WARP SHALL NOT EXCEED 0.05mm.
8. ALL GROUND LEADS AND GROUND PADDLE MUST BE SOLDERED TO PCB RF GROUND.
9. REFER TO HITTITE APPLICATION NOTE FOR SUGGESTED PCB LAND PATTERN.

## MMIC VCO w/ BUFFER AMPLIFIER, 3.9 - 4.45 GHz

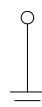
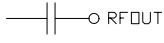
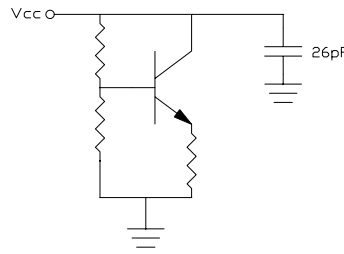
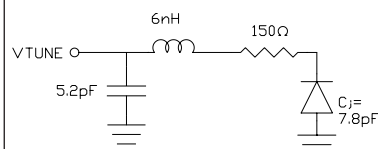
### Pin Descriptions

Pin Number	Function	Description	Interface Schematic
1- 14, 17 - 19, 21, 23, 24	N/C	No Connection	
15	GND	This pin must be connected to RF & DC ground.	
16	RFOUT	RF output (AC coupled)	
20	Vcc	Supply Voltage Vcc= 3V	
22	VTUNE	Control Voltage Input. Modulation port bandwidth dependent on drive source impedance.	
	GND	Package bottom has an exposed metal paddle that must be RF & DC grounded.	

## MMIC VCO w/ BUFFER AMPLIFIER, 3.9 - 4.45 GHz

### Evaluation PCB

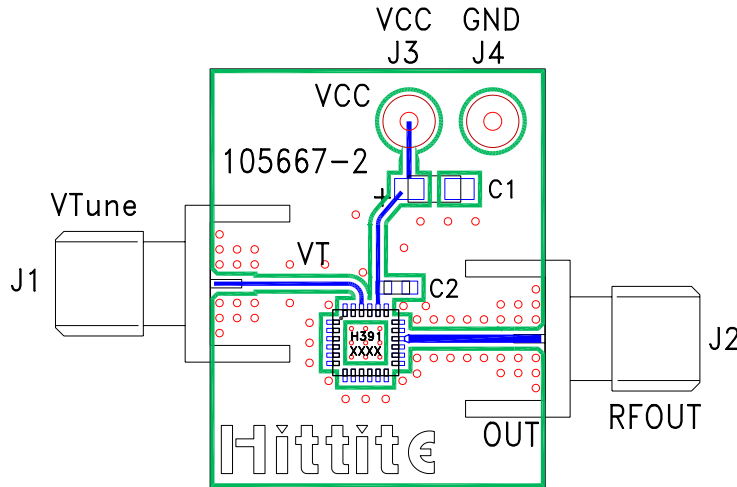

### List of Materials

Item	Description
J1 - J2	PC Mount SMA RF Connector
J3 - J4	DC Pin
C1	4.7 µF Tantalum Capacitor
C2	10,000 pF Capacitor, 0603 Pkg.
U1	HMC391LP4 VCO
PCB*	105667 Eval Board
* Circuit Board Material: Rogers 4350	

The circuit board used in the final application should use RF circuit design techniques. Signal lines should have 50 ohm impedance while the package ground leads and exposed paddle should be connected directly to the ground plane similar to that shown. A sufficient number of via holes should be used to connect the top and bottom ground planes. The evaluation circuit board shown is available from Hittite upon request.

## *MMIC VCO w/ BUFFER AMPLIFIER, 3.9 - 4.45 GHz*

**Notes:**